

Privacy Shelter

Privacy Shelter

Thank you for purchasing this product. Before using, please carefully read this manual for instructions on the proper care and usage of this product.

If you have any questions regarding this product, please contact Montbell Customer Service or the store of original purchase. Keep this manual for future reference.

■ Description

Designed for use indoors to provide privacy in evacuation centers (gymnasiums, community centers, etc.) during disaster and emergency situations. Sets up easily to create a space large enough for two adults to rest with room to spare.

■ Components

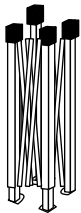
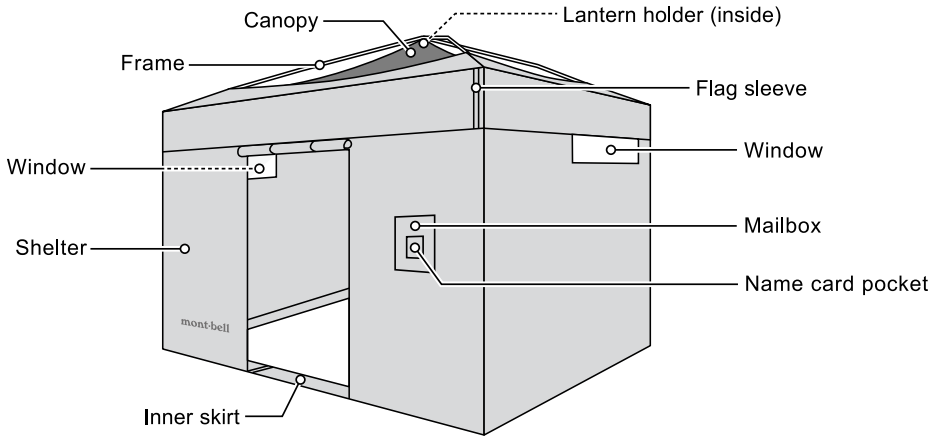

Frame



Main body



Canopy



Flag pole

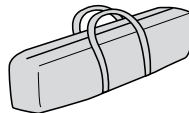

Carrying case



User's manual

* Before using, make sure that all parts are present.

■ Safety Warnings! Please read carefully.



DANGER!

Under certain conditions, use of this product can result in major injury or death.

- To prevent carbon monoxide poisoning, do NOT burn fuels near the product (generators, gas stoves, charcoal, etc).
- NEVER place a flame source in or near the product. Injury or death by fire and/or carbon monoxide poisoning is possible.
- Regularly open the entrance to make sure the interior is well-ventilated.



WARNING!

Under certain conditions, use of this product can result in injury, death, or property damage.

- Before using the product in an evacuation center, obtain permission from the person or organization in charge of the evacuation center.
- When selecting a site, check the safety of the surrounding area.
- Do NOT climb on, hang or place excessive loads on this product. May cause the product to break or collapse.
- Do NOT allow this product to come into contact with electricity or fire. The frame is made of metal, so there is a risk of electrical shock.
- Do NOT modify or alter this product. Improper modifications and alterations can damage the product and impair functionality.
- Prior to use, check the product's condition and stop using immediately if you notice any deterioration from age/use, damage or irregularities.
- Please follow recommended care and storage instructions. Improper care and storage can lead to a decrease in performance.



CAUTION!

Under certain conditions, use of this product can result in injury or property damage.

- When hot, ventilate as often as possible to adjust the temperature.
- This product is for indoor use ONLY. Set up away from the effects of wind and rain. Do NOT use this product outdoors.
- When setting up the shelter, try to set it up on a relatively flat surface and avoid setting it up in hazardous areas.
- Ultraviolet rays from the sun will damage the product's fabric.
- We recommend practicing setting up the shelter to familiarize yourself with the product and its features.
- Setting up and taking down this product requires 2 or more people. Setting up and taking down this product alone may result in excessive force being applied to the fabric or frame, leading to damage.
- Each part has sharp edges. Be careful when handling the product and individual parts.
- When setting up or taking down this product, be careful not to pinch your fingers in the frame or other parts of the product. Failure to do so may result in injury.
- Do NOT allow small children to set up this product.
- Do NOT move this product while it is set up. The frame may damage the floor.
- This product is heavy. Please be careful when carrying it.
- Do NOT drag this product when transporting it. Doing so may damage the product.

■ Prior to use, inspect this product for: Stop using immediately if you notice any irregularities.

- Cracks or damage on the frame
- Tears or damage to shelter fabric
- Loose screws or joints

■ Directions

○ Setting up

Setup requires 2 or more people. Setting up this product alone may result in excessive force being applied to the fabric or frame, resulting in damage.

* Set up with as many people as necessary.

① Extend the four frame legs downward until you hear the lock pins click into place.

* Be careful not to pinch your fingers.

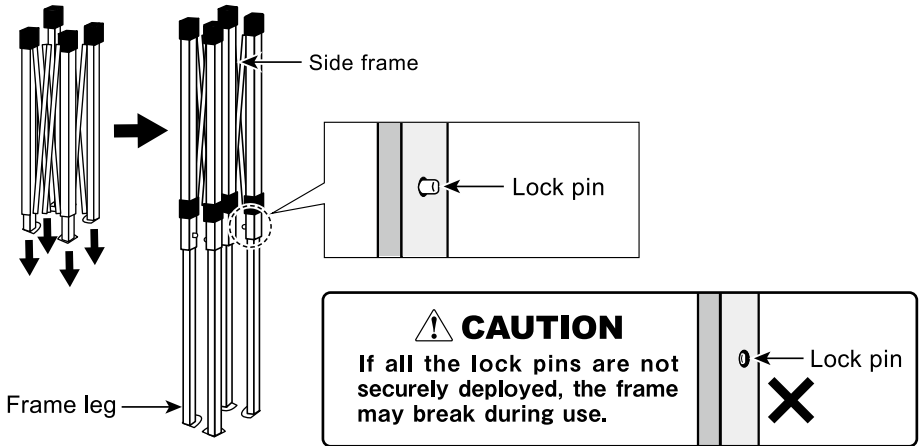

② Holding the frame legs, slightly open up the frame in a diagonal direction.

* Be careful not to pinch your fingers.

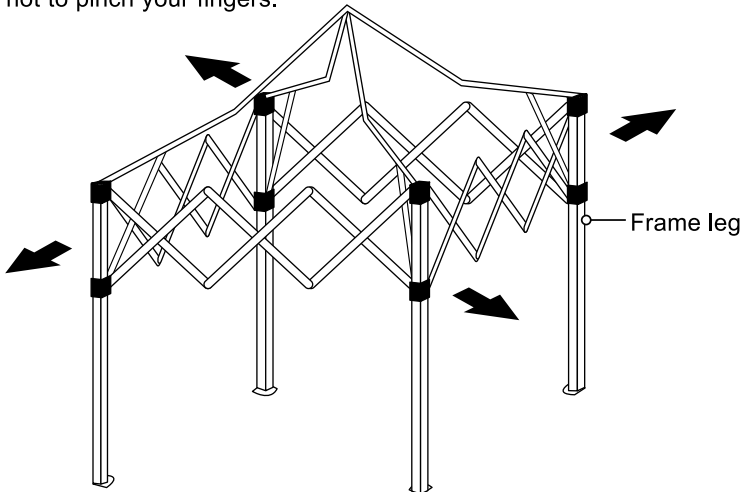

- ③ Align the four corners of the shelter's main body with the frame, and secure the hook-and-loop straps around the top of the frame legs (4 places/Fig. A). Next, secure the hook-and-loop straps on the upper edge of the main body to the frame (4 places/Fig. B).

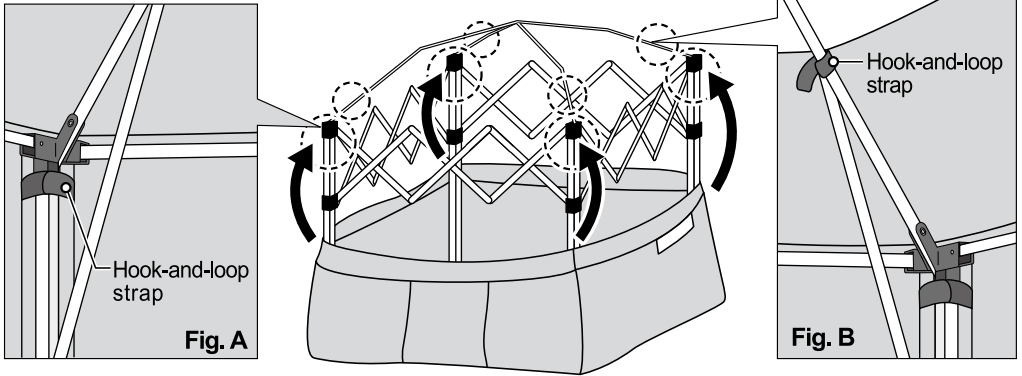

- ④ Pass the toggles (located on the upper interior of the main body) and loops over the frame joints (8 places) and fasten.

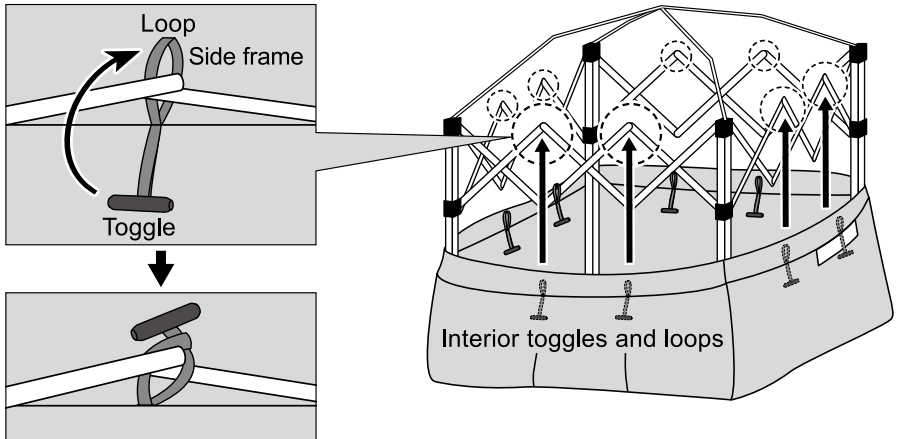

* Place the frame feet on top of the inner skirt at each corner to prevent the fabric from rising or flapping.

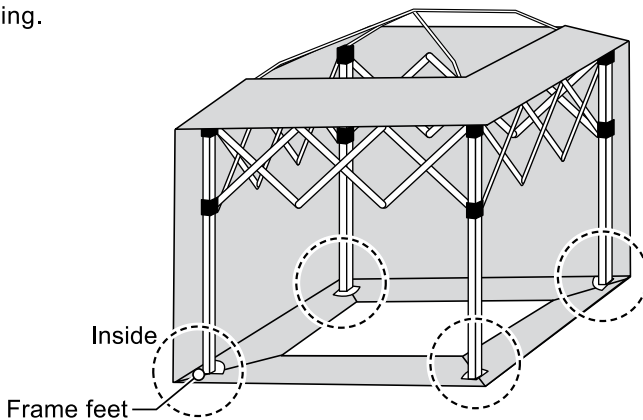

- 5 While holding the frame legs and opening up the frame in a diagonal direction, raise the joints located at each corner. Secure the frame by pushing up on the joints until each lock pin clicks into place inside each joint. * Be careful not to pinch your fingers.

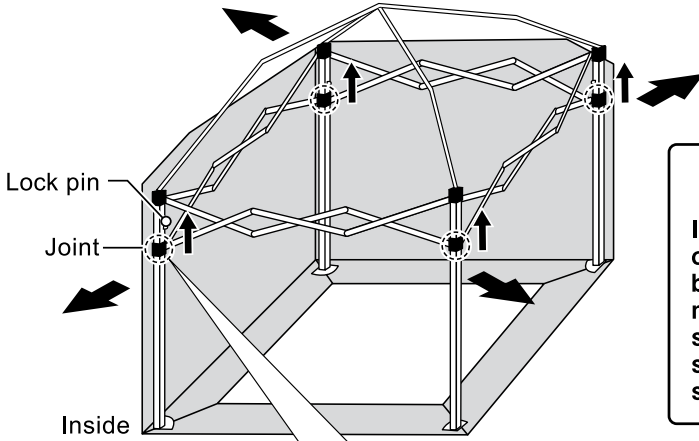

! CAUTION

If the frame feet and the corners of the shelter's main body are misaligned, setup may not be possible due to strain on the shelter. Forcibly setting up the shelter in this state may result in damage.

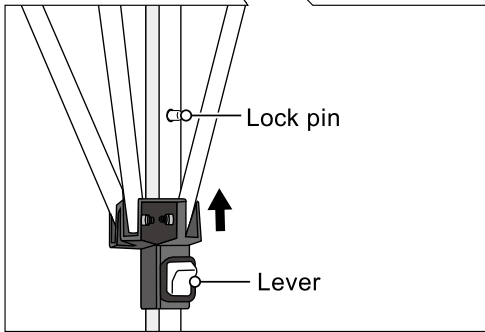

When frame is secured

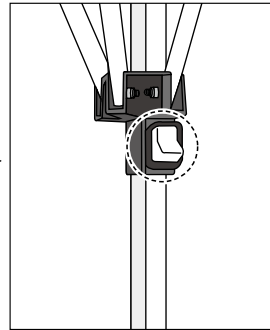

! CAUTION

Be careful where you push up on the frame. Pushing up in the wrong place or way may cause damage.

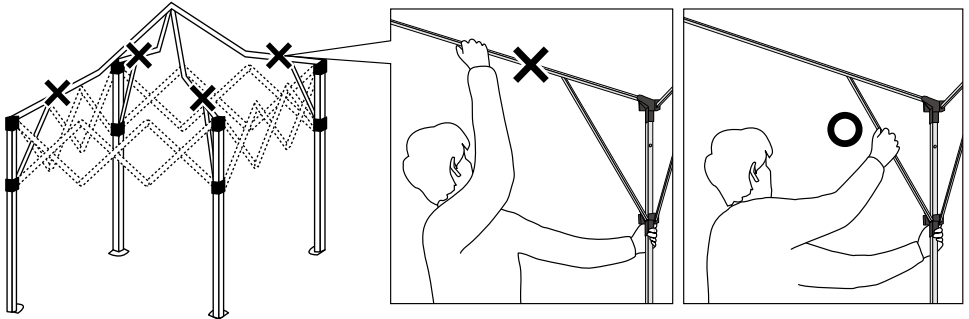

○ Attaching the canopy

The shelter comes with a canopy that is useful when trying to shut out light for sleep. When the canopy isn't in use it can be rolled up.

- ① Attach the hook on the canopy to the apex of the frame.

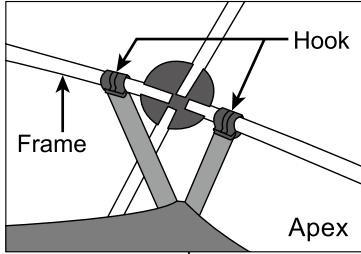

- ② Attach the canopy's four hooks to the four loops on each corner of the shelter.

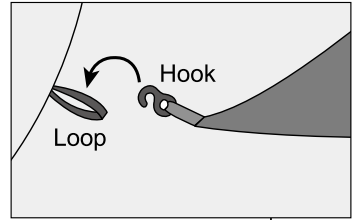

- ③ When the canopy isn't in use, the loop and toggle can be used to roll it up.

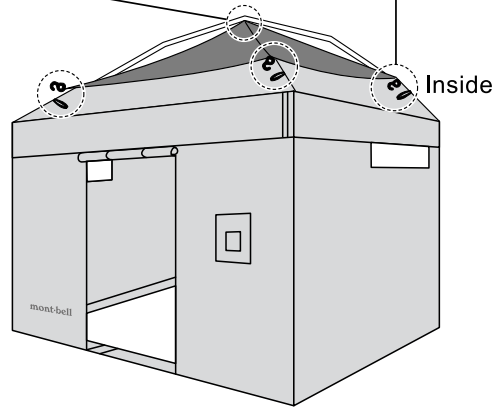
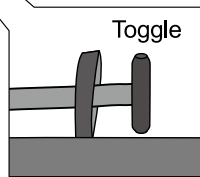
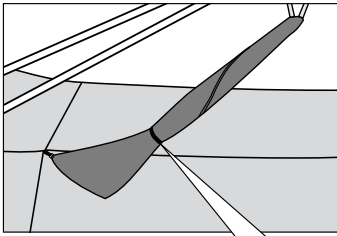

○ Lantern holder

The top of the canopy has a ring for hanging a lantern (NOT included). Do NOT hang heavy objects. Doing so may cause damage to the frame.

⚠ CAUTION

Do NOT use flammable lanterns or lights (fueled by gasoline, gas, etc.). May result in fire or carbon monoxide poisoning.

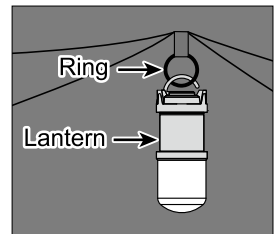

*Lantern NOT included with this product.

○ Using the flag pole and flag sleeve

❶ To easily identify your shelter, assemble the flag pole and attach a piece of paper or cloth. Use an adhesive such as a piece of tape, or tie off some cloth at the top.

* Cloth and paper are NOT included.

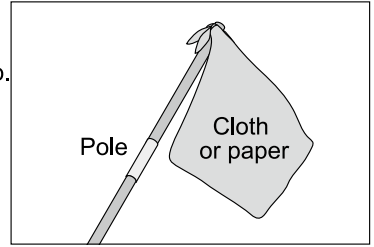

❷ Insert the flag pole fully into the flag sleeve and make sure it is secure.

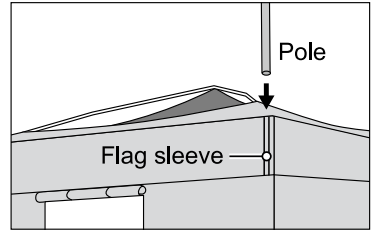

○ Using the entrance and windows

The entrance and both windows roll up from the inside. Keep them rolled up using the toggles.

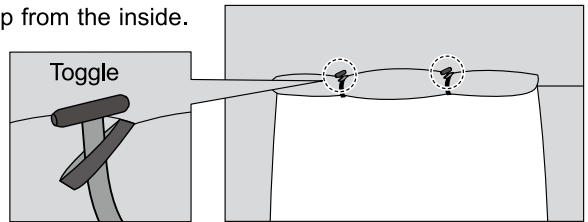

○ Taking down the shelter

Release the lock pins on the joints and frame legs, then take down the shelter in the reverse order of assembly.

* Be careful not to pinch your fingers when releasing the lock pins or folding up the frame.

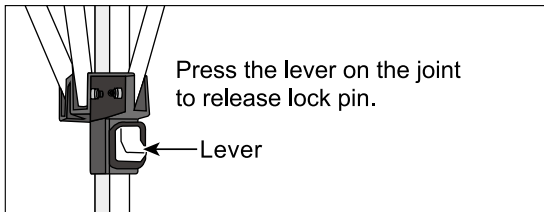

■ Care

Improper care and storage can shorten the lifespan of this product.

To extend the lifespan of this product, please follow the recommendations below.

- Wash away stains and soiling with water. Avoid direct sunlight and allow to air dry in a cool, well-ventilated area. If stored wet or soiled, mold can grow and the fabric can start to prematurely deteriorate.
- Do NOT dry clean or machine wash. This can damage the product's fabric.
- Do NOT dry clean or wash in a washing machine. This can damage the product's fabric.
- Do NOT clean with volatile solvents (thinner, benzene, alcohol, etc.). May cause discoloration or deterioration.

■ Storage

- If not using this product for a long period of time, store in a well-ventilated place away from direct sunlight.
- To prevent deformation and damage to the product, do NOT store near heat sources.
- Do NOT store in a place subject to temperature extremes (e.g. inside a car).
- Do NOT place heavy objects on the main body or canopy when storing. Pressure and friction may cause color transfer. Even if this happens, the functionality of the product is unaffected.

■ Disposal

- Please follow local regulations regarding waste disposal.

■ Warranty

Montbell's warranty covers all defects in materials and workmanship to the original owner, for the lifetime of the product. If a product ever fails due to a manufacturing defect, Montbell will repair or replace the product at Montbell's discretion. This warranty does not cover damage(s) caused by accident, improper care, negligence, misuse, alterations or normal wear and tear. Damage(s) not covered under warranty will be repaired at a reasonable rate. If you would like to make a warranty inquiry, please contact Montbell Customer Service or the store of original purchase.

■ Specifications

Dimensions

* Units are in centimeters.

- #1122758
Privacy Shelter

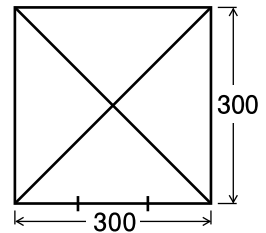
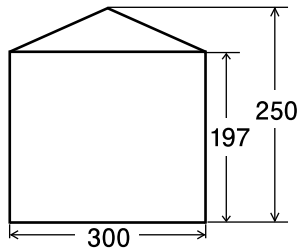

Materials

- Shelter main body/canopy: 75 denier polyester taffeta, 70 denier nylon taffeta
- Frame: steel

All product specifications and design are subject to change without prior notice. Actual product specifications may vary.

mont-bell Co.,Ltd.

2-2-2 Shinmachi, Nishi-ku, Osaka 550-0013 JAPAN

<https://www.montbell.com/>